

- Switching and linear technology
- 1 charging level
- Versions for non-sealed and sealed lead-acid batteries, 1.25 to 12A ratings
- Charging current limitation selectable.

Automatic battery chargers for lead-acid batteries

	SEC. - PAGE
Switching BCF series, modular version	24 - 2
Switching BCG series	24 - 3
Linear BCE series	24 - 4
Dimensions	24 - 5
Wiring diagrams	24 - 6
Technical characteristics	24 - 7



Page 24-2

SWITCHING BATTERY CHARGERS MODULAR VERSION

- For lead-acid batteries up to 50Ah rating
- Rated output current:
 - 2.5 and 4.5A at 12VDC
 - 1.25 and 2.5A at 24VDC
- Electronic lock for shorted battery, reverse polarity and output overload
- Automatic reset at end of alarm conditions
- Output for alarm remote indication.



Page 24-3

SWITCHING BATTERY CHARGERS

- For lead-acid batteries up to 150Ah rating
- Rated output current:
 - 6A and 12A at 12VDC
 - 5A and 10A at 24VDC
- Electronic lock for shorted battery, reverse polarity and output overload
- Automatic reset at end of alarm conditions
- Output for alarm remote indication.



Page 24-4

LINEAR BATTERY CHARGERS

- For lead-acid batteries up to 150Ah rating
- Rated output current:
 - 3A, 6A, 12A at 12VDC
 - 2.5A, 5A, 10A at 24VDC
- Electronic lock for shorted battery, reverse polarity, output overload and disconnected battery
- Output for alarm remote indication.

24 Automatic battery chargers

Switching BCF series

For lead-acid batteries. Modular version



BCF...

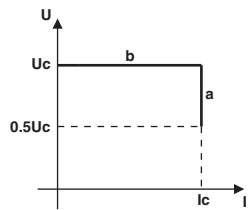

a - constant current charge
b - constant voltage charge

Order code	Rated output current	Rated output voltage in DC	Qty per pkg	Wt
	[A]	[V]	n°	[kg]
1 charging level.				
BCF025012	2.5	12	1	0.332
BCF045012	4.5		1	0.336
BCF012524	1.25	24	1	0.332
BCF025024	2.5		1	0.332

Alarms	VDC ON GREEN LED	BAT LOW RED LED	RELAY
Correct output voltage	ON	OFF	Energised
Reverse polarity	ON	ON	Energised
Short circuit/Overload	OFF	OFF	De-energised

Type	Maximum power consumption		dissipation	Internal fuse mains side (Type T)
	[VA]	[W]	[W]	[A]
BCF025012	80	40	6	2ⓘ
BCF045012	150	70	9	2ⓘ
BCF012524	80	39	6	2ⓘ
BCF025024	150	77	9	2ⓘ

ⓘ Not replaceable.

General characteristics

- Switching technology
 - Wide auxiliary supply range
 - Screw fixing or 35mm DIN rail mount (IEC/EN/BS 60715).
- Protection:
- Mains input fuse
 - Battery output fuse
 - Electronic lock in case of short circuit on battery terminals, reverse battery polarity and output overload
 - Automatic reset at end of alarm conditions.

LED indications:

- Correct output voltage
- Reverse battery polarity.

Operational characteristics

- Auxiliary supply voltage: 100...240VAC ±10% 50/60Hz ±5%
- Fixed charging current
- Current limitation
- Charging current according to DIN 41773 standards
- Fixed clamping screw terminal block with captive screws
- IEC degree of protection: IP20.

Alarm output circuit

- Type of output: 3A 250VAC AC1 duty relay, normally energised.

Certifications and compliance

Certifications obtained: EAC; UL Recognized for USA and Canada (cURus - File E360865), as Power Supplies - Component.
Products having this type of marking are intended for use as components of complete workshop-assembled equipment.
Compliant with standards: IEC/EN/BS 62368-1, IEC/EN/BS 61000-6-2, IEC/EN/BS 61000-6-3, UL 60950-1, CSA C22.2 n°60950-1.

For lead-acid batteries



BCG...



BCGX00

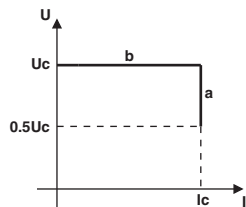

a - constant current charge
b - constant voltage charge

Order code	Rated output current	Rated output voltage in DC	Qty per pkg	Wt
	[A]	[V]	n°	[kg]
1 charging level.				
BCG0612	6	12	1	0.532
BCG1212	12		1	0.710
BCG0524	5	24	1	0.532
BCG1024	10		1	0.710
Accessories.				
BCGX00	Adapter for 35mm DIN rail vertical mount of BCG0612 and BCG0524		1	0.022

Alarms	ON GRN LED	REV RED LED	ALA RED LED	CHG YEL RED	RELAY
Correct output voltage	ON	OFF	OFF	OFF	Energ.
Charging	ON	OFF	OFF	ON①	Energ.
Low battery voltage	ON	OFF	ON	ON②	De-energ.
Reverse polarity	OFF	ON	OFF	OFF	De-energ.
Short circuit / Overload	ON	OFF	ON	OFF	De-energ.

- ① Steady light if the charging current is more than approx. 30% of programmed current value.
- ② Flashing during Hiccup operating conditions.

Type	Maximum power consumption			Internal fuse
	[VA]	[W]	[W]	Mains side (type T)
BCG0612	230	97	14	4③
BCG1212	284	290	29	6.3
BCG0524	364	158	20	6.3③
BCG1024	630	311	41	8

③ Not replaceable.

General characteristics

- Switching technology
- Wide auxiliary supply range
- High efficiency
- Two charging voltages selectable by DIP-switch
- Boost external control for full battery charging
- Hiccup function for battery recharging when its voltage is lower than 50% rated value
- Charging current limiting trimmer resistor
- Screw fixing or 35mm DIN rail mount (IEC/EN/BS 60715).

Protection:

- Input fuse on AC side
- Electronic lock in case of short circuit on battery terminals, reverse battery polarity and output overload
- Automatic reset at end of alarm conditions.

LED indications:

- Power on
- Charging operation ($I > 30\% I_c$)
- Overload or short circuit conditions
- Reverse battery polarity.

Operational characteristics

- Auxiliary supply voltage: 110...240VAC $\pm 10\%$ 50/60Hz $\pm 10\%$
- Charging voltage selectable by DIP-switch
- Maximum charging current can be set with a trimmer on the front: 20...100% of the rated current value
- Current limitation
- Charging cycle according to DIN 41773 standards
- IEC degree of protection: IP20.

Alarm output circuit

- Type of output: 5A 30VDC duty relay, normally energised.

Certifications and compliance

Certifications obtained: EAC; UL Recognized for USA and Canada (cURus - File E360865), as Power Supplies - Component.

Products having this type of marking are intended for use as components of complete workshop-assembled equipment. Compliant with standards: IEC/EN/BS 62368-1, IEC/EN/BS 61000-6-2, IEC/EN/BS 61000-6-4, UL 60950-1, CSA C22.2 n°60950-1.

For lead-acid batteries



31BCE0312
31BCE2V524



31BCE0612
31BCE0524



31BCE1212
31BCE1024

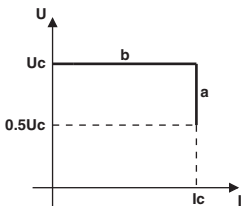

a - constant current charge
b - constant voltage charge

Order code	Rated output current [A]	Rated output voltage in DC [V]	Qty per pkg n°	Wt [kg]
1 charging level.				
31BCE0312	3	12	1	1.984
31BCE0612	6		1	4.832
31BCE1212	12		1	8.690
31BCE2V524	2.5	24	1	1.992
31BCE0524	5		1	4.960
31BCE1024	10		1	9.560

Alarms	ON GREEN LED	ALARM RED LED	CHARGE GREEN LED	RELAY
Correct output voltage	ON	OFF	OFF	Energ.
Charging	ON	OFF	ON	Energ.
Low battery voltage	ON	ON	OFF	De-energ.
Reverse polarity	ON	ON	OFF	De-energ.
Short circuit / Overload	ON	ON	OFF	De-energ.
Battery disconnected	ON	ON	OFF	De-energ.

Type	Maximum power consumption [VA]	dissipation [W]	Mains fuse (type) [A]
	BCE0312	117	24
BCE0612	222	46	4 (F) int
BCE1212	400	73	6.3 (F) int
BCE2V524	166	26	1 (T) ext ①
BCE0524	317	40	4 (F) int
BCE1024	610	66	6.3 (F) int

① Not supplied; installed by customer.

General characteristics

- Linear technology
 - Housing for internal panel mounting by screws.
- Protection:
- Mains input fuse (except for BCE2V5 and BCE03)
 - Battery output fuse
 - Electronic lock in case of short circuit on battery terminals, reverse battery polarity, output overload (<0.5 U_e) and disconnected battery.

LED Indications:

- Power on
- Charge (I > 0.2 I_c)
- Alarm for protection tripping.

Operational characteristics

- Auxiliary supply voltage: 220...240VAC ±10%, 50/60Hz ±5%
- Charging current: 30...100% I_e adjustable
- Charging cycle according to DIN 41773 standards
- Current limitation
- Clamping screw terminal block with captive screws:
 - Removable for BCE03 and BCE2V5
 - Fixed for BCE05, BCE06, BCE10 and BCE12
- IEC degree of protection: IP00.

Alarms

Possible causes of alarm include:

- Low battery voltage
- Battery fuse blown
- Battery not connected
- Battery polarity inverted (reverse polarity).

BCE2V524 - BCE0312

These types have a static alarm output for the control of a relay or indicator, maximum 300mA duty.

If it is connected to a relay, this must be normally energised in absence of alarm. In alarm conditions with ALARM LED switched on or in absence of supply, the relay de-energises.

BCE0524 - BCE0612 - BCE1024 - BCE1212

These types have a normally energised relay alarm output. In alarm conditions with ALARM LED switched on or in absence of supply, the relay de-energises.

Alarm output circuit

BCE2V524 - BCE0312

- Type of output:
 - Negative static; NPN transistor ②
 - Maximum voltage applicable to load: +V battery terminal
 - Maximum output current: 300mA
 - Maximum over-voltage current for 1 second: 2A
 - Dynamic over-voltage protection with inductive load.

BCE0524 - BCE0612 - BCE1024 - BCE1212

- Type of output
 - Relay: 1 changeover contact (SPDT)
 - Rated voltage: 250VAC
 - IEC rated capacity in AC1 duty: 5A 250VAC Ith
 - IEC rated capacity in DC13 or DC14 duty: 5A 30VDC
 - Electrical life: >10⁵ cycles
 - Mechanical life: >30x10⁵ cycles.

② The output is not overload or short-circuit protected. It is however capable of switching on a 3W filament bulb.

Certifications and compliance

Certifications obtained: EAC.
Compliant with standards: IEC/EN/BS 60950-1.

DERATING CURVES

BCE2V524 - BCE0312

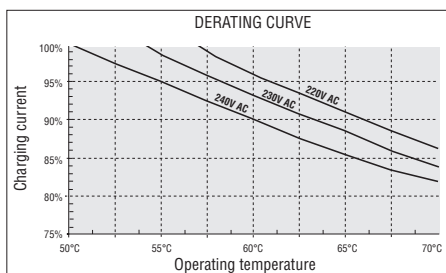

BCE0524 - BCE0612

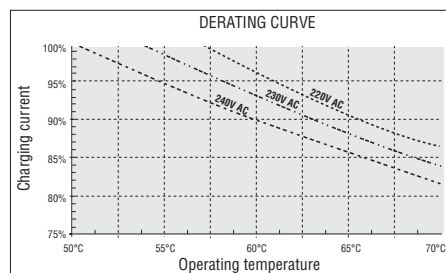

BCE1024 - BCE1212

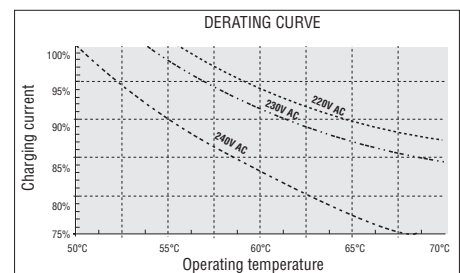

24 Automatic battery chargers

Dimensions [mm (in)]

BCF...

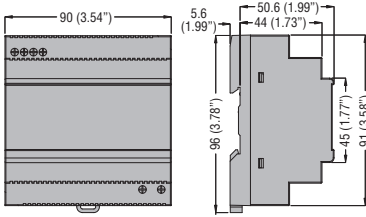

BCG0612 - BCG0524

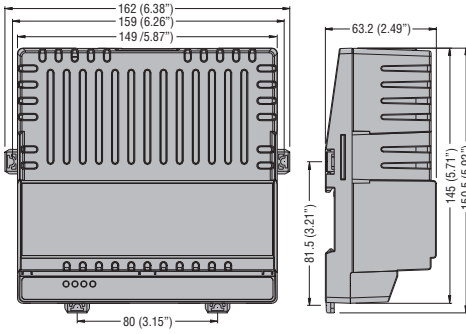

Mounting adapter **BCGX00**

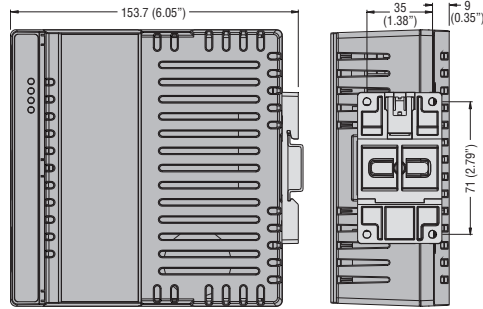

BCG1212 - BCG1024

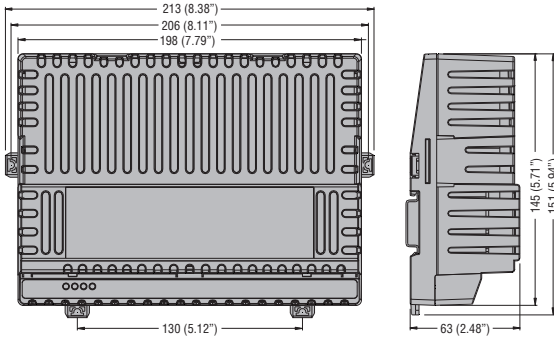

BCE0312 - BCE2V524

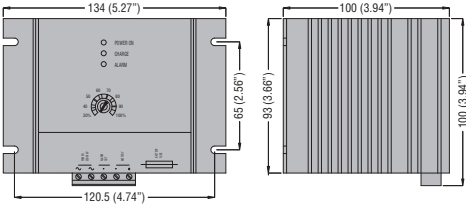

BCE0612 - BCE0524

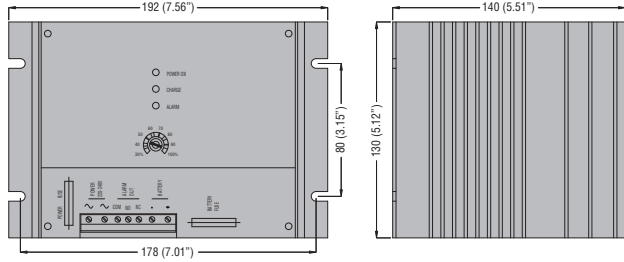

BCE1212 - BCE1024

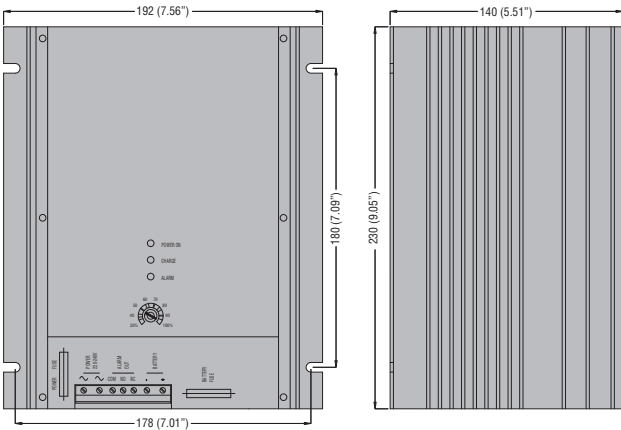

BCF...

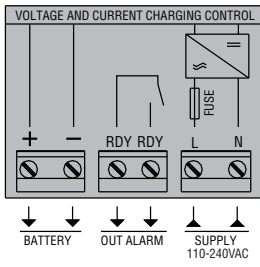

BCG...

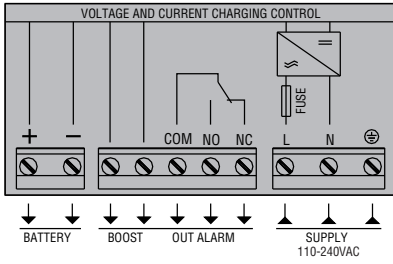

BCE2V5... - BCE03...

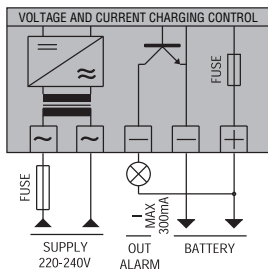

BCE05... - BCE06... - BCE10... - BCE12...

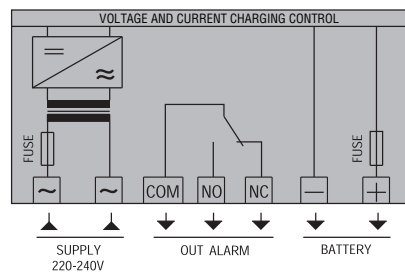

TYPE	BCF...	BCG...	BCE...
Description	Single phase automatic battery charger 1 charging level for lead-acid batteries	Single phase automatic battery charger 1 charging level for lead-acid batteries	Single phase automatic battery charger 1 charging level for lead-acid batteries
Supply voltage	100...240VAC ±10% 50/60Hz ±5%	110...240VAC ±10% 50/60Hz ±10%	220...240VAC ±10% 50/60Hz ±5%
Rated output voltage (Uoc)	12-24VDC		
Rated charging current (Ic)	2.5-4.5A (12VDC) 1.25-2.5A (24VDC)	6-12A (12VDC) 5-10A (24VDC)	3-6-12A (12VDC) 2.5-5-10A (24VDC)
CHARGING CYCLE			
Reference standards	DIN 41773		
Diagram	<p>a - constant current charge b - constant voltage charge</p>		
End charging voltage U _c	12V battery: 13.6VDC (2.27V/cell) 24V battery: 27.2VDC (2.27V/cell)	12V battery with DIP2: – in pos. V1: 13.8V – in pos. V2: 13.5V (default) 24V battery with DIP2: – in pos. V1: 27.6V – in pos. V2: 27.0V (default)	12V battery: 13.8VDC (2.3V/cell) 24V battery: 27.6VDC (2.3V/cell)
Charging current	Fixed	Adjustable 20% to 100% I _c (using potentiometer/trimpot)	Adjustable 30% to 100% I _c (using potentiometer)
Current limit	Yes		
Boost	—	+4.4% U _c	—
PROTECTION			
Type	<ul style="list-style-type: none"> – Mains supply fuse – Charging inhibition due to: <ul style="list-style-type: none"> • Short circuit at battery terminals • Reverse battery polarity • Low voltage at battery poles (<0.5 U_{oc}) • Output overload 	<ul style="list-style-type: none"> – Mains supply fuse – Charging inhibition due to: <ul style="list-style-type: none"> • Short circuit at battery terminals • Reverse battery polarity • Low voltage at battery poles (<0.5 U_{oc}) • Output overload 	<ul style="list-style-type: none"> – Mains supply fuse (5, 6, 10, 12A types only) – Battery output fuse – Charging inhibition due to: <ul style="list-style-type: none"> • Short circuit at battery terminals • Reverse battery polarity • Low voltage at battery poles (<0.5 U_{oc}) • Disconnected battery
ALARM OUTPUT CIRCUIT			
Type of output	1 relay 3A 250VAC AC1	1 relay 5A 30VDC	Static (NPN transistor) ①; relay with 1 c/o contact (SPDT), 5A 250VAC ②
AMBIENT CONDITIONS			
Operating temperature	-40...+51°C	-30...+55°C (+55...+70°C with 1-5%I _c /°C derating by trimpot)	-10...+50°C
Storage temperature	-40...+85°C	-30...+80°C	-30...+80°C
HOUSING			
Version	Modular	Internal panel mount	Internal panel mount
Mounting	35mm DIN rail (IEC/EN/BS 60715)	35mm DIN rail (IEC/EN/BS 60715) or screw fixing	Screw fixing
IEC degree of protection	IP20	IP20	IP00
Cooling	Natural		
Connections	Fixed terminals	Fixed terminals	Removable/plug-in terminals① Fixed terminals②

① For 2.5A and 3A types only.
② For 5, 6, 10 and 12A types only.